

**Description:**

Ideal for light duty applications with a cylindrical lockset with 1/2" to 5/8" throw (5/8 requires 1/8" door gap), for use in wood, metal or aluminum door frames.

- For use with offset and cylindrical locksets
- Continuous duty operation (DC)
- Fully reversible for right or left hand doors
- 5 years limited warranty

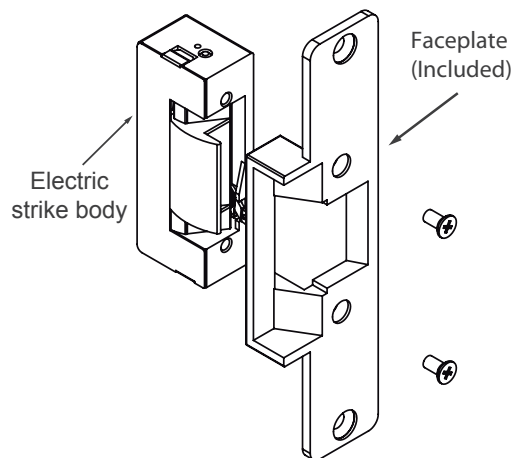
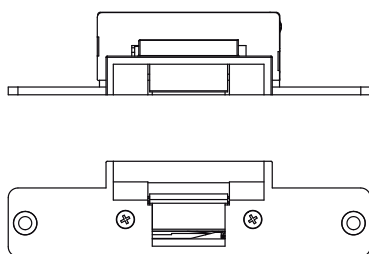
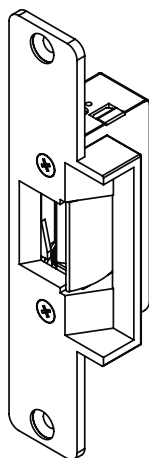
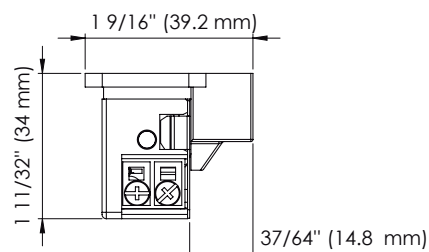

**Jamb Door Installation**

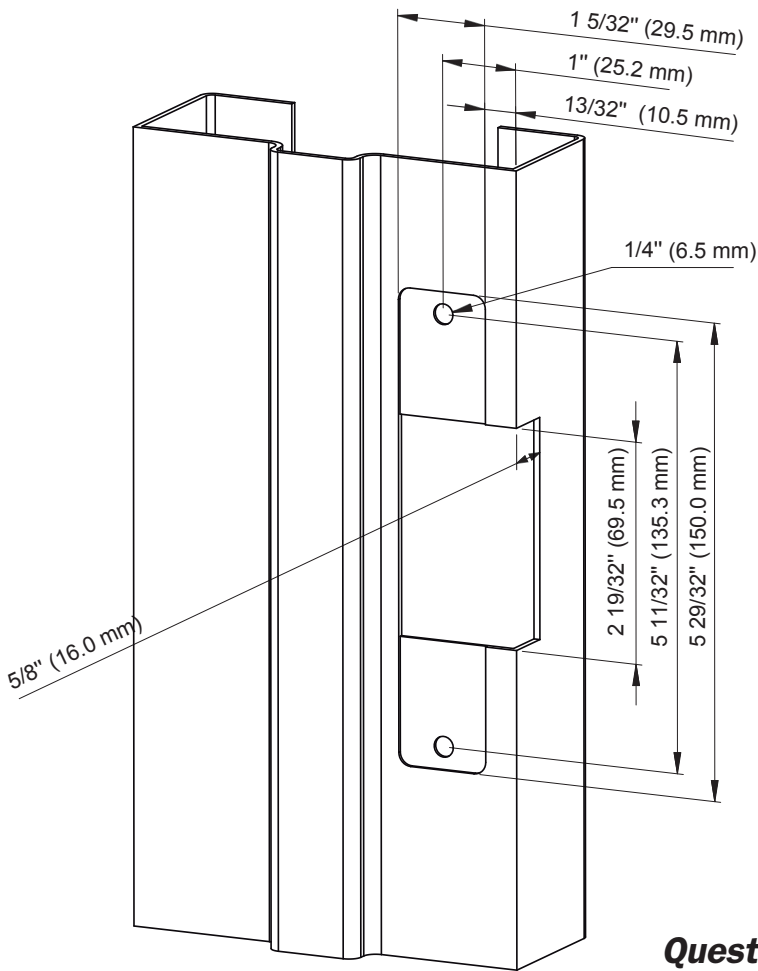
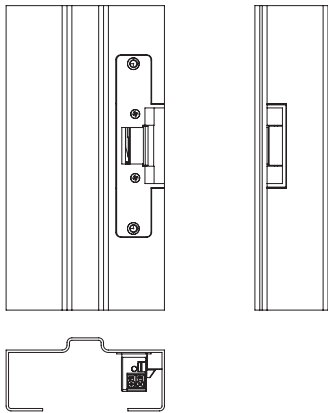

| Technical Features                  |                               | CX-EL0051    |
|-------------------------------------|-------------------------------|--------------|
| Height                              | 2 15/16" (75.3 mm)            |              |
| Width                               | 1 9/16" (39.3 mm)             |              |
| Depth                               | 1 5/16" (34.0 mm)             |              |
| Suits Latches With Maximum Throw Of | 9/16" (14.3 mm)               |              |
| Endurance Cycle Test                | 200,000                       |              |
| Holding Force                       | 460 Lbs. (208 Kg.)            |              |
| Operating Temperature Range         | 5° to 104°F<br>(-15° to 40°C) |              |
|                                     |                               | <b>8-16V</b> |
| Rated Resistance                    | 17 ohms                       |              |
| AC Current Consumption              | 8V                            | 370 mA       |
|                                     | 16V                           | 750 mA       |
| Stabilized DC Current Consumption   | 8V                            | 470 mA       |
|                                     | 12V                           | 940 mA       |
| Max. Latch Preloaded AC             | 45 lbs. (20 Kg.)              |              |

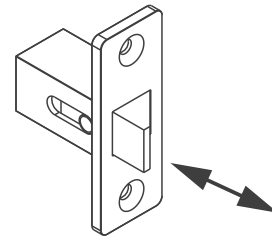

Verify that the latch works smoothly when installing

**Questions?**

**Call us toll-free at 1-877-226-3369**



Push Buttons



Key Pads



Strikes



Magnetic Locks



Key Switches



Relays & Timers



Access Control